

ACCESSORIES / BOARD

CA 552



CMR PLAY

Ürün Bilgisi / Product Information

Boyutlar / Dimensions : 0,85 x 0,25 x 2,8m
(L x W x H)

PANO / BOARD

Pano, ürünlerin kurulduğu alanlarda; ürünle ilgili bilgilendirme ve alanlarla ilgili uyarıları barındırır. Ürünlerin sağlıklı ve etkili kullanılması için kullanıma uygun fiziksel kriterleri ve kişileri belirtmek için oluşturulmuştur.

Board contains information and warnings about the product in the areas where the products are installed. For healthy and effective use of products, there are rules defining by physical criteria and persons suitable for usage.

ACCESSORIES / BOARD CA 552



Metal parts are comprised of ST 37 Steel with a 3-step metal finish. Sandblasting and solvent-free zinc primer coating and electrostatic powder paint application is inherently corrosion resistant under extreme weather conditions and UV.

Metal parçalar, 3 aşamalı metal kaplamalı ST 37 çelikten oluşur. Kumlama ve solvent içermeyen çinko astar kaplama ve elektrostatik toz boya uygulaması, aşırı hava koşulları ve UV altında olarak korozyona dayanıklıdır.



Digital printing is applied on the composite material. It is resistant to sun and weather conditions.

Kompozit malzeme üzerine dijital baskı şeklinde uygulama yapılmaktadır. Güneşe ve hava şartlarına karşı dayanıklıdır.

ACCESSORIES / **BOARD**
CA 552

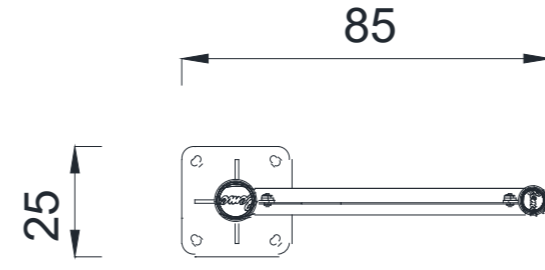

ÜST GÖRÜNÜŞ / **TOP VIEW**

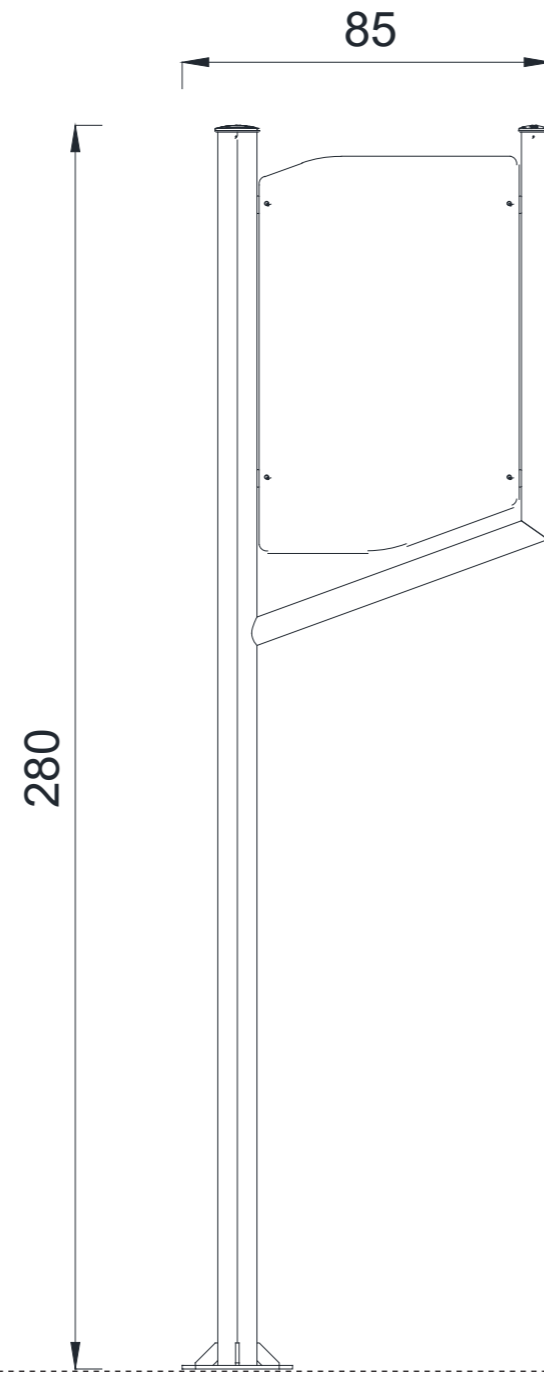

ÖN GÖRÜNÜŞ / **FRONT VIEW**

Gösterilen ölçüler cm cinsindedir / **Dimensions shown are in cm**



YAN GÖRÜNÜŞ / **SIDE VIEW**